

brilumen[®]



AR111 G53 20W

DATA SHEET



Technical specifications

Dados técnicos

Wattage Potência	20W
Color rendering index CRI Índice de restituição das cores	> 80
Rated luminous flux Fluxo luminoso	1800 lm
Led type Tipo de led	Sharp COB
Beam angle Ângulo de feixe	25°
Color temperature Temperatura da cor	6400K / 4200K / 2800K



External LED driver included
Driver externo incluído

Symbology

Simbologia

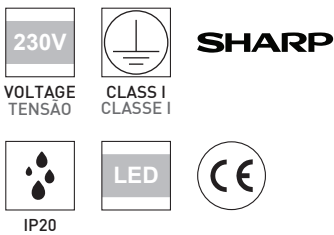

Dimensional drawing

Desenho dimensional

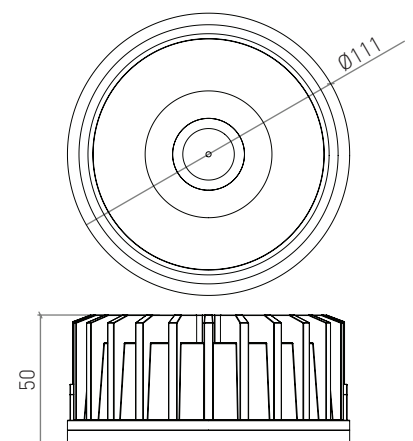





AR111 G53 20W



Options available on request

Opções disponíveis sob pedido

beam angle . ângulo de feixe	CRI >85 6400K 	CRI >85 4200K 	CRI >85 2800K 	CRI >92 4200K 	CRI >92 2800K 
25°	C1014-158.01	C1014-158.02	C1014-158.03	C1014-158.92.02	C1014-158.92.03

0-10V LED DRIVER

Available on request . Disponível sob pedido



8015-0206 . 300mA . 14,4-20W